

1

2

3

4

5

6

7

D

D

C

C

B

B

A

A

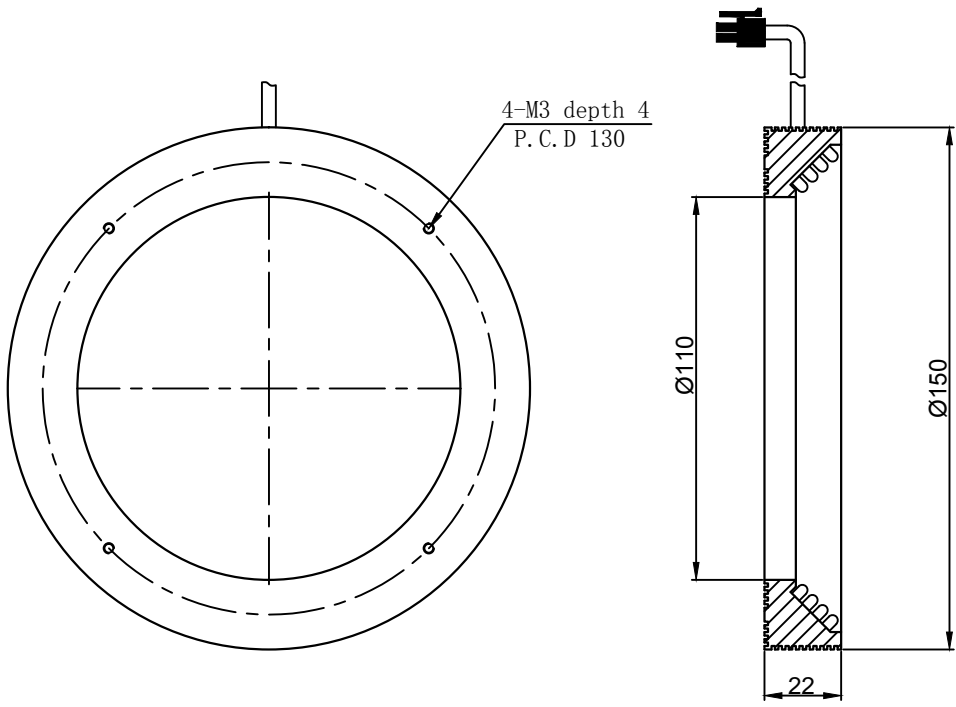

SPECIFICATIONS PARAMETER	
OPERATING VOLTAGE	DC24-26V
RATED CURRENT	IR / W. G. B 450/650mA
RATED POWER	IR / W. G. B 10.8/15.6W
PEAK CURRENT	IR / W. G. B 900/1300mA
PEAK POWER	IR / W. G. B 21.6/31.2W
WAVELENGTH OF LIGHT	IR 850-940nm
	R 620-625nm
	G 520-530nm
	B 465-470nm
	W 6500-7000K



PART NAME	HGS150RI445		DATE	2012-11-27
			DWN. BY	
UNIT: mm	TITLE	DRAWING LAYOUT		CHKD. BY
				APPD. BY
				DWG. NO

1

2

3

4

5

6

7