

1      2      3      4      5      6      7

D  
C  
B  
A

D  
C  
B  
A

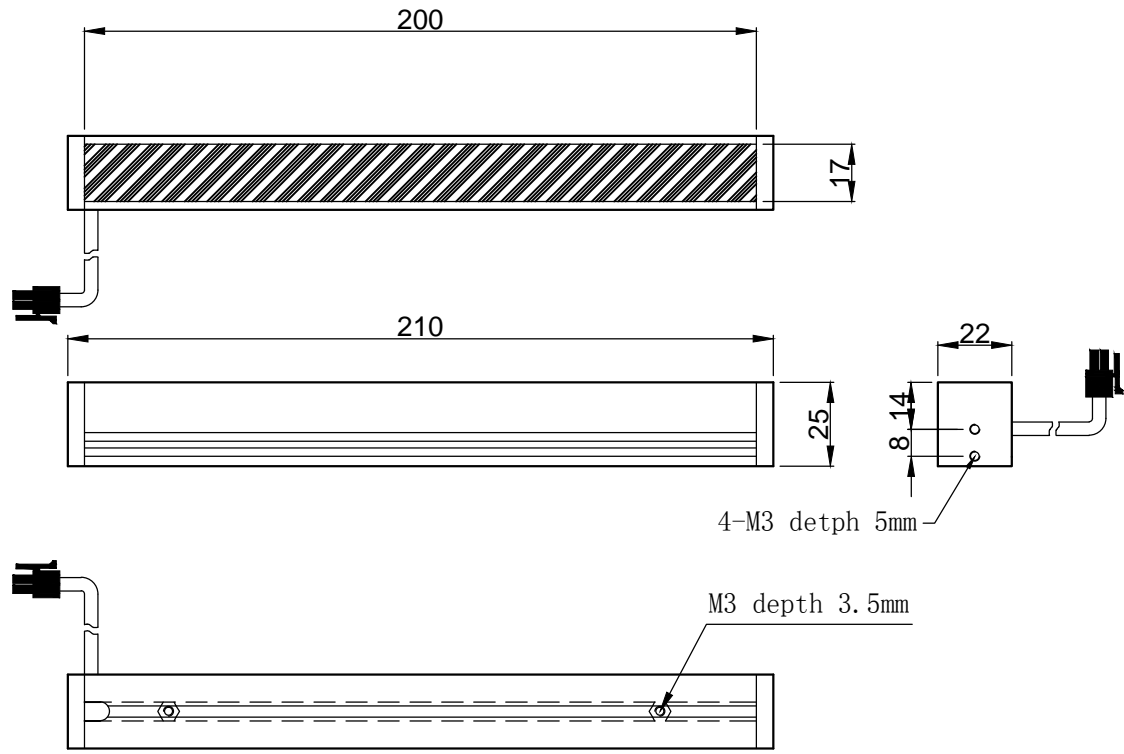

SPECIFICATIONS PARAMETER	
OPERATING VOLTAGE	DC24-26V
RATED CURRENT	IR, R / W, G, B 220/320mA
RATED POWER	IR, R / W, G, B 5.28/7.68W
PEAK CURRENT	IR, R / W, G, B 440/640mA
PEAK POWER	IR, R / W, G, B 10.54/15.36W
WAVELENGTH OF LIGHT	IR 850-940nm
	R 620-625nm
	G 520-530nm
	B 465-470nm
	W 6500-8000K



PART NAME	HGS200SSD17		DATE	2013-9-23
UNIT: mm	TITLE	DRAWING LAYOUT	DWN. BY	
			CHKD. BY	
			APPD. BY	
			DWG. NO	

1      2      3      4      5      6      7