

1 2 3 4 5 6 7

D

D

C

C

B

B

A

A

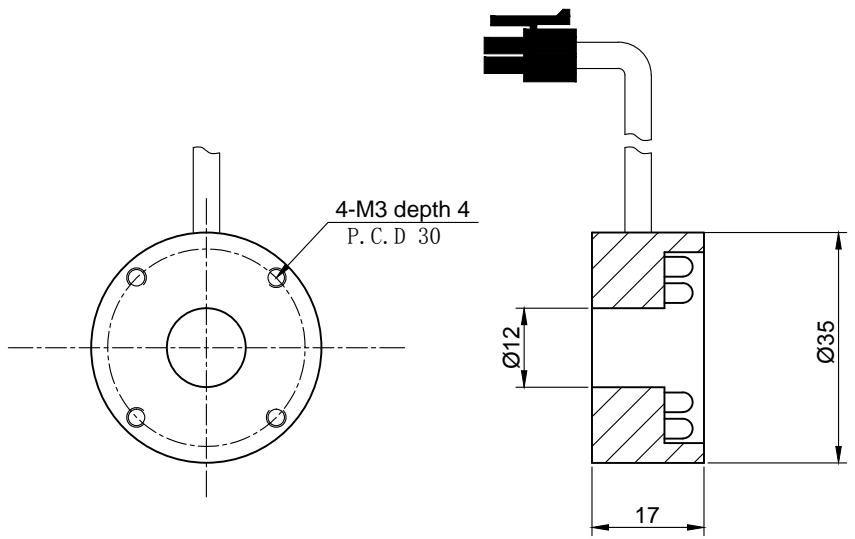

SPECIFICATIONS PARAMETER	
OPERATING VOLTAGE	DC24-26V
RATED CURRENT	IR, R/W, G, B 45/60mA
RATED POWER	IR, R/W, G, B 1.08/1.44W
PEAK CURRENT	IR, R/W, G, B 90/120mA
PEAK POWER	IR, R/W, G, B 2.16/2.88W
WAVELENGTH OF LIGHT	IR 850-940nm
	R 620-625nm
	G 520-530nm
	B 465-470nm
	W 6500-8000K



PART NAME	HGS35RI200		DATE	2015-8-5
UNIT: mm	TITLE	DRAWING LAYOUT	DWN. BY	
			CHKD. BY	
			APPD. BY	
			DWG. NO	

1 2 3 4 5 6 7