

1 2 3 4 5 6 7 8

Rev No.	Description	Date	Name

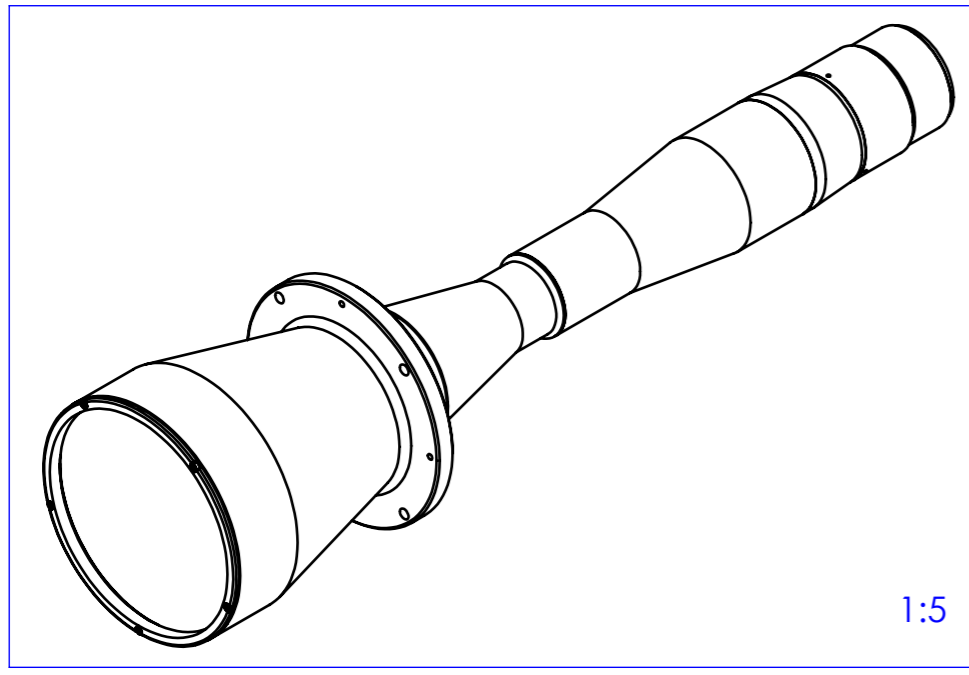
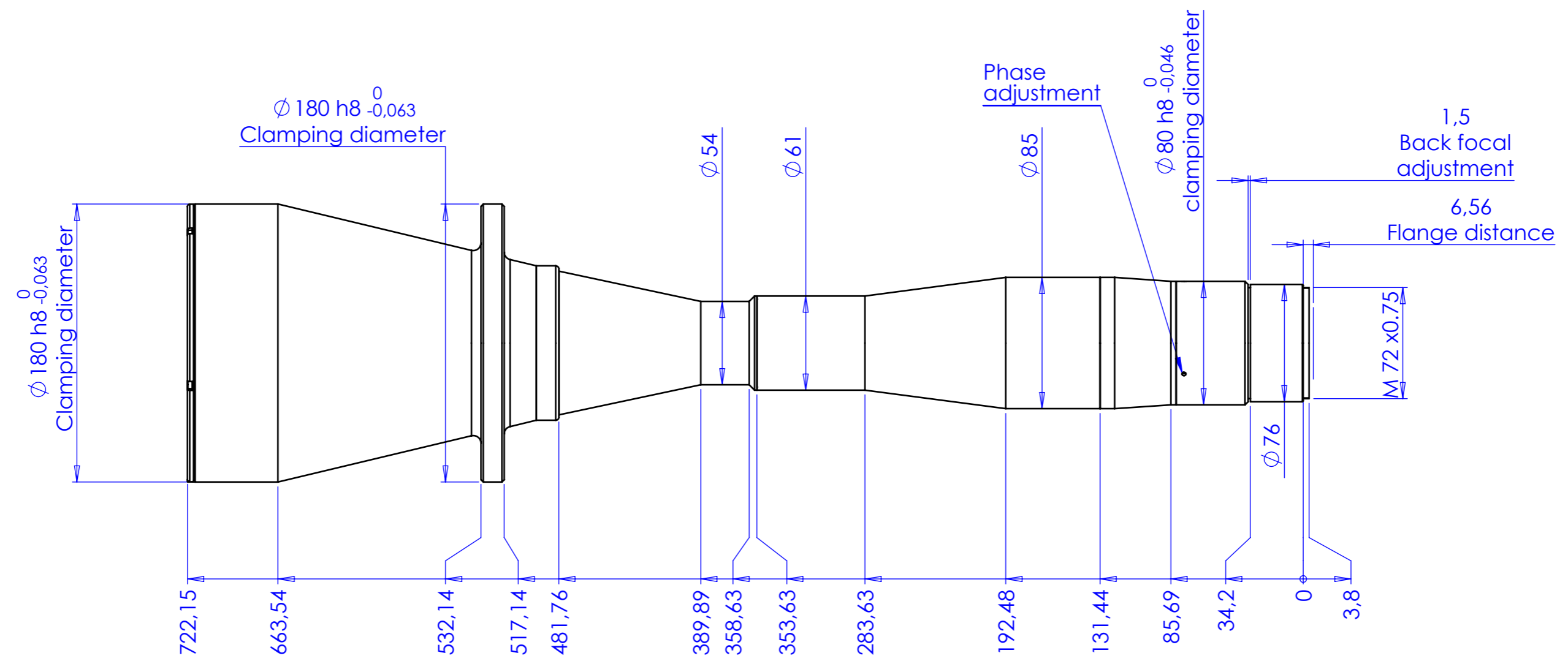

Material	N.A.		Mass	6001 g	Scale	1:3
Surface treatment	N.A.		Part No.	CO20130		
Geometrical tolerance (ISO 2768-2)			Class	K	Undimensioned bevels	0,5x45°
Linear tolerance (ISO 2768-2)			Class	m	Undimensioned radii	R 0.5
0.5 ±3	>3± 6	>6± 30	>30± 120	>120 ±400	>400± 1000	>1000 ±2000
±0.1	±0.1	±0.2	±0.3	±0.5	±0.8	±1.2
			Date	Name	Drawing No.	
			Designed	02/01/2015	Rodella	DP 20130-A
			Drawn	15/01/2015	Rodella	
			Checked			
<b>OPTO ENGINEERING S.r.l. - Mantova Italy - Tel. +39 0376 699111 - www.opto-engineering.com</b>			Secret and confidential - All rights reserved - No copy, dissemination or circulation is allowed unless specifically authorized in writing by OPTO ENGINEERING S.r.l. - Any violation shall be legally prosecuted.		Sheet 1/1	

1 2 3 4 5 6 7 8

0 1 2 3 4 5 6 7 8 9 10